

MCM

TOGETHER, THE FUTURE IS BUILT

MCM T250

TELESCOPIC LOADER

POWER. REACH.
PERFORMANCE.

Built for tough jobs.
Designed for the future.



Website :
www.MCMGROUP.co.za



Instagram :
[mcm.company](https://www.instagram.com/mcm.company)



Facebook :
MCM GROUP

MCM T250

TELESCOPIC LOADER



■ Engine

Machine	T250
Model	Yunnei YN38GB
Net Peak Power	76kW (100HP) @ 2400 rpm
Type	Direct Injection, Water Cooled
No. of Cylinders	4-Cylinder Diesel Engine
Fuel Tank Capacity	120 Litres











■ Transmission System

Type	Hydraulic Transmission Box	
Gears Forward/Reverse	2 Forward / 2 Reverse	
Travel Speed	km/h	20
Max. Torque	Nm	245
Transfer Case	4WD	
Brake Control	Single Line, Air Brake	

■ Operation Dimensions

Total Travel Length	mm	5000
Total Travel Height	mm	2850
Total Travel Width	mm	1950
Wheel Track	mm	2430
Bucket Width	mm	1820
Ground Clearance	mm	345

■ Attachments

Augers	Breakers	Brush Cutters	Buckets	Earth Drills
				
Forks	Grapples	Rippers	Shears	And More
				

■ Operation Parameters

Operating Weight	kg	5500
Rated Load	kg	2500
Bucket Capacity	m ³	1.2
Max. Dumping Height	mm	3880
Max. Working Height	mm	5165
Min. Dumping Distance	mm	1720
Max. Dumping Angle	degrees	40-45
Max. Tractive Force	kN	41
Max. Breakout Force	kN	62
Hydraulic Flow Rate	L/min	104
System Pressure	MPa	20
Min. Turning Radius	degrees	34
Max. Ground Clearance	mm	345

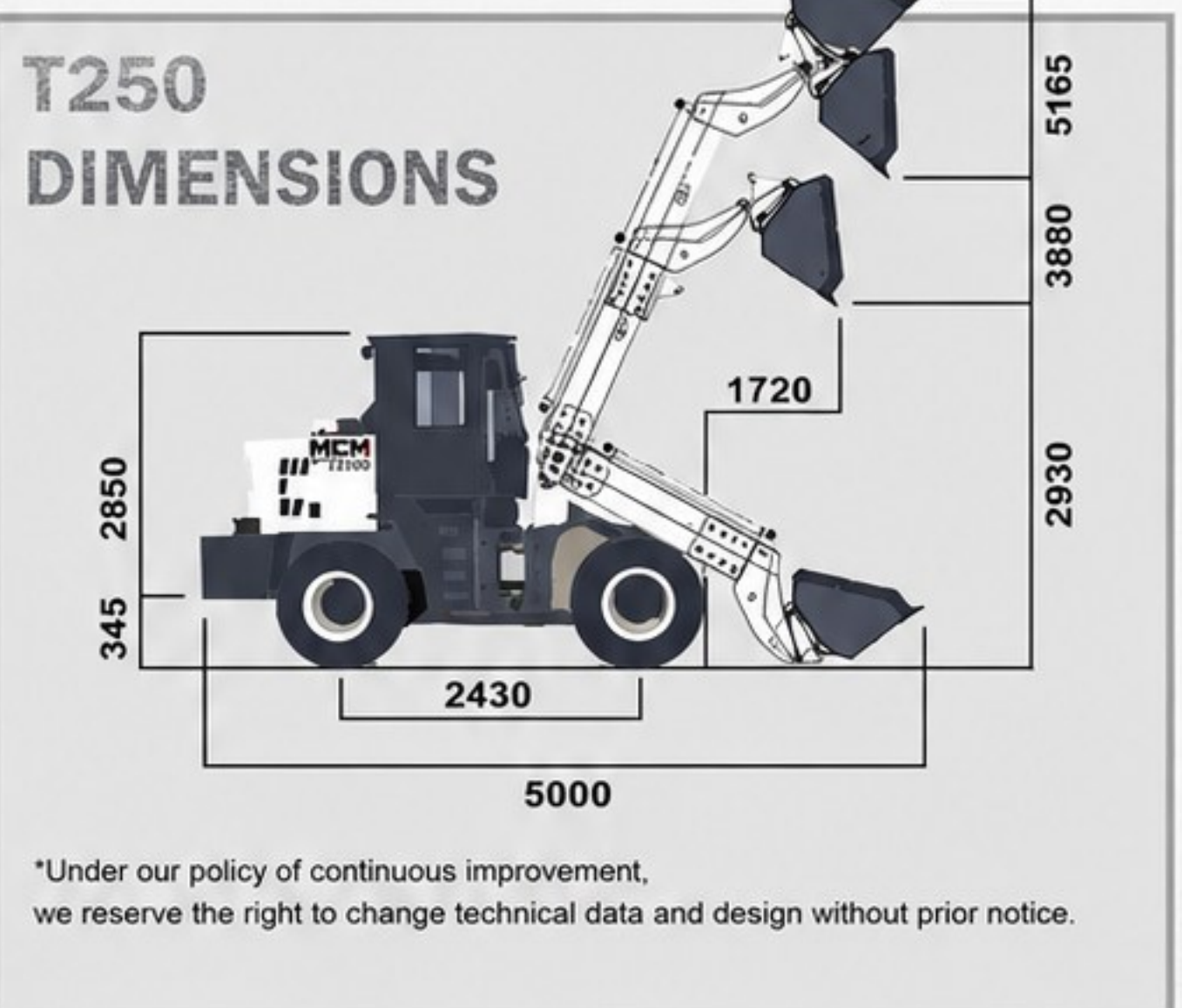

www.MCMGROUP.co.za

CAPE TOWN
9 Karee Rd, Kraaifontein
Industria, Cape Town, 7570

SALES (+27) 21 001 8686

ruan@mcmco.co.za

GEORGE
Jura Lands, Beach Road,
Hansmoeskraal, George, 6529

SALES (+27) 44 878 2917

chris@mcmco.co.za

FREE STATE
Bloem Showgrounds,
Curie Avenue, Generaal De Wet,
Bloemfontein, 9301

SALES (+27) 84 022 7300

clarence@mcmco.co.za

GAUTENG
26 Sterling Rd, Unit 1,
Samrand Business Park,
Midrand, 0117

SALES (+27) 12 030 3451

sales@mcmco.co.za