



HZM

HZM **811T**

TELESCOPIC LOADER

**POWER.
REACH.
PERFORM.**



PROUDLY DISTRIBUTED BY MCM



Website : www.MCMGROUP.co.za



Instagram : [mcm.company](https://www.instagram.com/mcm.company)



Facebook : [MCM GROUP](https://www.facebook.com/MCMGROUP)



HZM 811T

TELESCOPIC
LOADER

Technical Specifications

**POWER.
REACH.
PERFORM.**

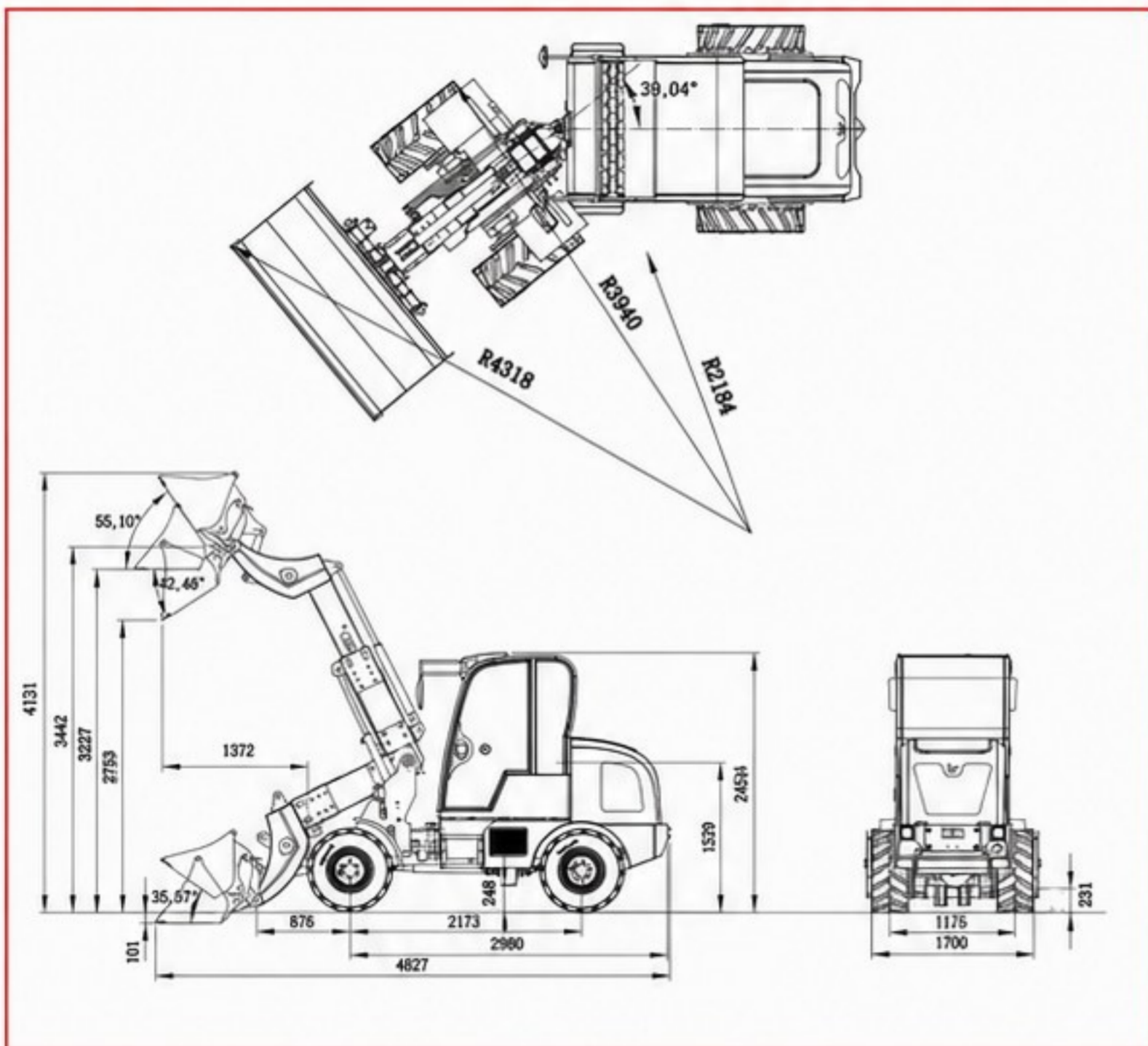

SPECIFICATION

Overall weight(kg)	2900
L×W×H (mm)	4610X1270X2450mm
Rated bucket capacity(m ³)	0.4-0.5
Rated load(kg)	1000
Maximum dump height (mm)	3227
Pallet fork lift height (mm)	3200
Bucket indicator	Yes

ENGINE

Model	XINCHAI C490BPG
Type	Vertical, In-line, Water cooling, four-stroke diesel engine
Rated power(kw)	36.8kw
Rated speed(r/min)	2400

TRANSMISSION SYSTEM

Model of torque converter	YJ240
Gearbox type	Fixed-spindle power shift
Gear shift	2 gears ahead, 2 gear astern

HYDRAULIC SYSTEM

Working pressure	16Mpa
Boom lifting time	4.8s
Fuel tank capacity	35L

STEERING SYSTEM

Type	hydraulic steering
Min. turning radius(mm)	2750

TIRES

Standard tires	10-16.5
----------------	---------



www.MCMGROUP.co.za

CAPE TOWN

9 Karee Rd, Kraaifontein Industria,
Cape Town, 7570

 SALES (+27) 21 001 8686

 ruan@mcmco.co.za

GEORGE

Jura Lands, Beach Road,
Hansmoeskraal, George, 6529

 SALES (+27) 44 878 2917

 chris@mcmco.co.za

FREE STATE

Bloem Showgrounds,
Curie Avenue, Generaal De Wet,
Bloemfontein, 9301

 SALES (+27) 84 022 7300

 clarence@mcmco.co.za

GAUTENG

26 Sterling Rd, Unit 1,
Samrand Business Park,
Midrand, 0117

 SALES (+27) 12 030 3451

 sales@mcmco.co.za